

# Ultracell®

'Quality in Every Language'

UCG250-12

12V 250Ah

Solar Series

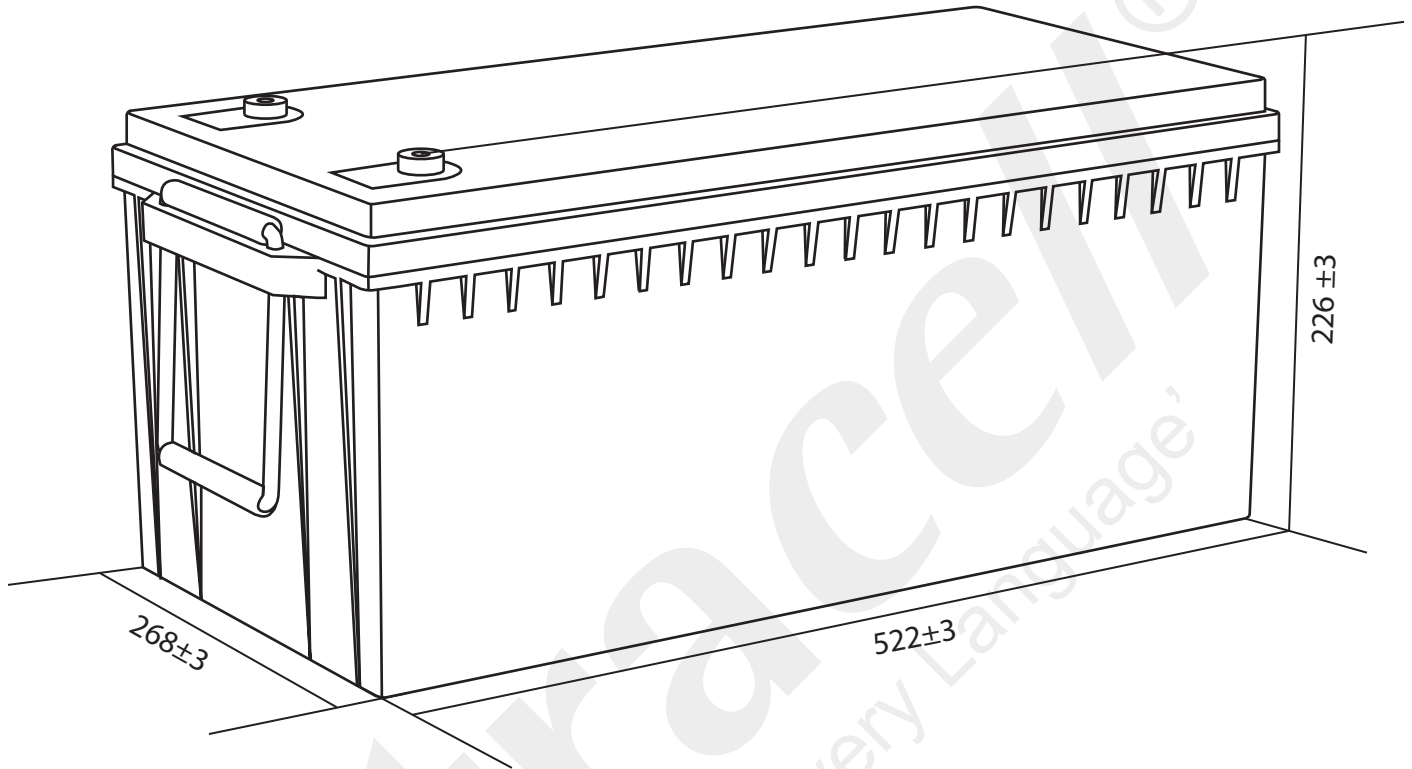

## Technical Dimensions (mm)

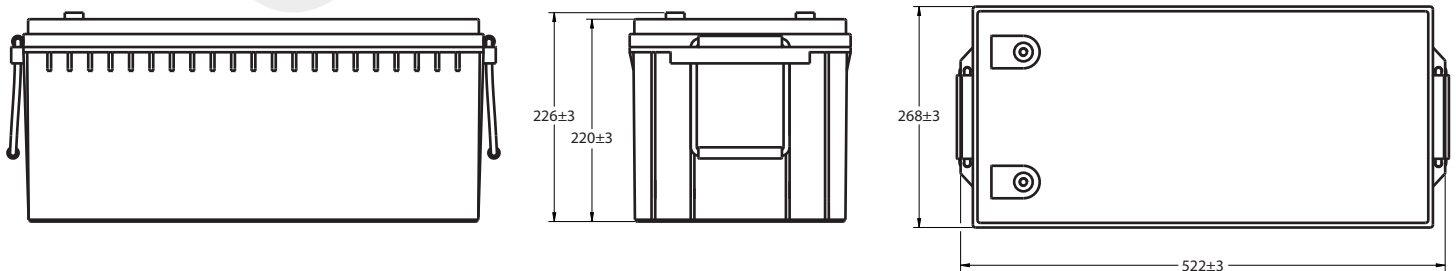



Image



Terminal Dimensions (mm)

Standard Terminal: F11

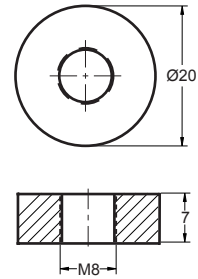

Technical Specification

<b>Output</b>	Nominal Voltage	12V
	Nominal Capacity (10HR)	250Ah
<b>Terminal Type</b>	Standard Terminal	F11
<b>Container Material</b>	Standard Option	ABS
	Flame Retardant Option (FR)	ABS (UL94:VO)
<b>Rated Capacity</b>	(20HR 1.80V/cell, 25°C)	258.0 Ah/12.9A
	(10HR 1.80V/cell, 25°C)	250.0 Ah/25A
	(5HR 1.75V/cell, 25°C)	212.5 Ah/42.5A
	(3HR 1.75V/cell, 25°C)	184.5 Ah/61.5A
	(1HR 1.60V/cell, 25°C)	149.3 Ah/149.3A
<b>Max Discharge Current</b>	2500A (5s)	
<b>Internal Resistance</b>	Approx 2.5mΩ	
<b>Discharge Characteristics</b>	Operating Temp Range	Discharge: -15 ~ 50°C Charge: 0 ~ 40°C Storage: -15 ~ 40°C
	Nominal Operating Temp Range	25 ± 3°C
	Cycle Use	Initial Charging Current less than 75A. Voltage 14.4V ~ 15.0V @ 25°C Temp. Coefficient -30mV/°C
	Standby Use	Initial Charging Current less than 75A. Voltage 13.5V ~ 13.8V @ 25°C Temp. Coefficient -20mV/°C
	Capacity affected by Temperature	40°C 103% 25°C 100% 0°C 86%
<b>Design Floating Life at 20°C</b>	10 Years	

Self Discharge

Ultracell® UCG batteries may be stored for up to 9 months at 25°C and then a refresh charge is required. For higher temperatures the time intervals will be shorter.

Constant Current Discharge / Constant Power Discharge At 25°C (Amperes & Watts/Cell)

F.V/TIME	10	15	20	30	45	60	2	3	4	5	6	8	10	20
A W	min	min	min	min	min	min	hours	hours	hours	hours	hours	hours	hours	hours
1.85V/cell	316.9	269.5	225.4	178.1	135.3	111.9	71.2	55.3	45.5	38.6	33.6	27.4	23.2	12.5
1.80V/cell	589.8	506.7	428.1	341.3	261.2	216.9	138.6	108.1	89.1	75.9	66.4	54.3	46.1	24.9
1.75V/cell	734.5	595.7	491.8	387.9	294.2	240.0	149.8	115.5	94.4	81.3	70.9	57.7	49.6	25.6
1.70V/cell	809.9	655.4	534.4	410.0	308.5	252.6	156.5	119.3	97.3	83.1	72.7	58.5	50.0	25.8
1.65V/cell	493.4	386.4	306.5	230.5	170.5	137.5	85.1	63.6	51.5	43.7	37.9	30.1	25.4	13.3
1.60V/cell	871.5	697.0	563.0	429.4	322.1	262.6	163.6	123.1	100.0	85.0	74.1	59.3	50.2	26.3
---	---	406.9	322.5	241.4	175.6	142.4	87.4	66.0	53.0	44.7	38.7	30.6	25.6	13.4
---	---	726.9	586.8	445.6	329.2	270.2	167.1	127.2	102.6	86.7	75.5	60.0	50.6	26.5
---	---	438.7	346.3	256.5	185.7	149.3	90.6	68.3	54.3	45.5	39.5	30.9	26.1	13.5
---	---	770.7	623.2	469.6	345.8	281.7	172.4	131.0	104.6	88.1	76.9	60.7	51.4	26.7



Discharge Characteristics

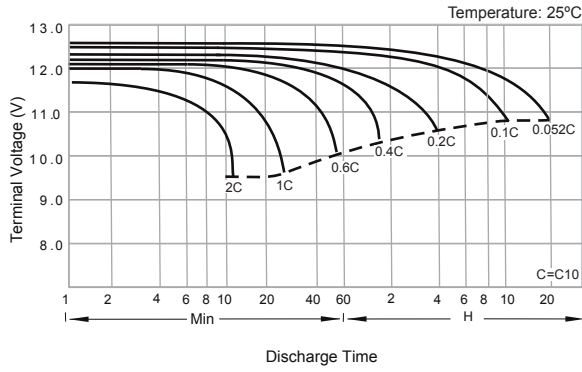

Float Charging Characteristics

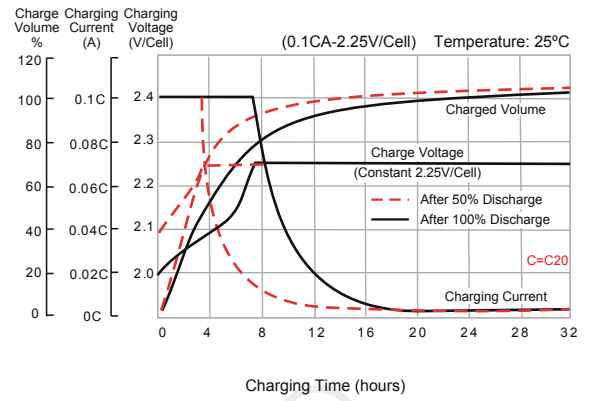

Temperature Effects in Relation to Battery Capacity

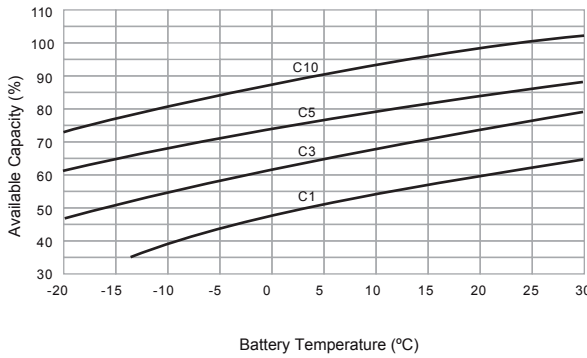

Effect of Temperature on Long Term Float Life

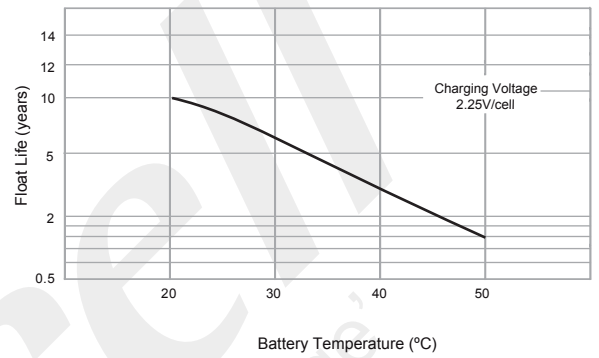

Cycle Life in Relation to Depth of Discharge

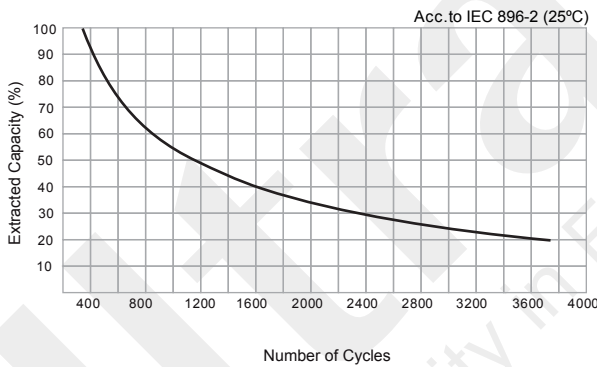

General Relation of Capacity vs. Storage Time

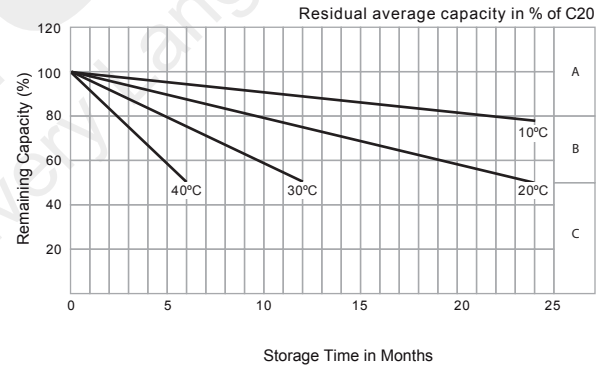

General Relation of Capacity vs. Storage Time (Notes)

- A) No supplementary charge required.  
(Carryout supplementary charge before use if 100% capacity is required.)
- B) Supplementary charge required before use. Optional charging way as below:
  1. Charged for above 3 days at limited current 0.25CA and constant voltage 2.25V/cell.
  2. Charged for above 20 hours at limited current 0.25CA and constant voltage 2.45V/cell.
  3. Charged for 8 ~ 10 hours at limited current 0.05 CA.
- C) Supplementary charge may often fail to recover the capacity.  
The battery should never be left standing till this is reached.