

Technical Dimensions (mm)

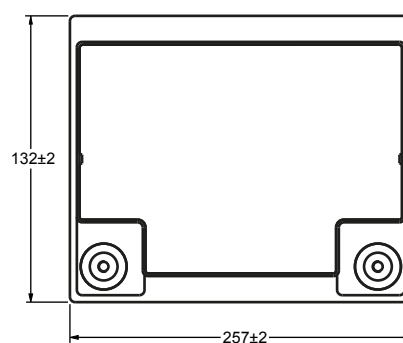

Image

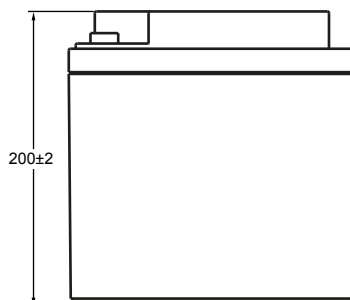
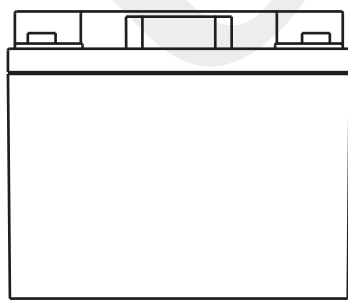

Terminal Dimensions (mm)

Standard Terminal: F6

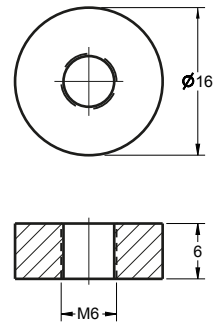

Technical Specification

Electrical Characteristics	Nominal Voltage	12.8V
	Nominal Capacity	50Ah
	Minimum Capacity	48Ah
	Energy	640Wh
Standard Charge	Charge Voltage	14.6V
	Standard Charge	0.2C CC charge to 3.65V/cell, then CV 3.65V/cell charge 3.5h
	Rapid Charge	1C CC charge to 3.65V/cell, then CV 3.65V/cell charge 3h
	Max. Charge Current	0.5C (A)
Standard Discharge	Continuous Discharge Current	2CA
	Discharge Cut-off Voltage	8.4V
Environmental Information	Charge Temperature	0 ~ 45°C
	Discharge Temperature	-20 ~ 60°C
	Storage Temperature	-20 ~ 45°C
Mechanical Information	Container Material	ABS
	Flame Retardant Option (FR)	ABS (UL94:VO)
	Standard Terminal	F6
Design Life	15 Years	
Battery Management System	Complete with BMS unit measuring current, voltage, single cell surface temperature and the ambient temperature of the battery.	

Self Discharge

Ultracell® LIT batteries may be stored for up to 2 years at 25°C and then a refresh charge is required. For higher temperatures the time intervals will be shorter.





Different Rate Discharge Curve (25°C)

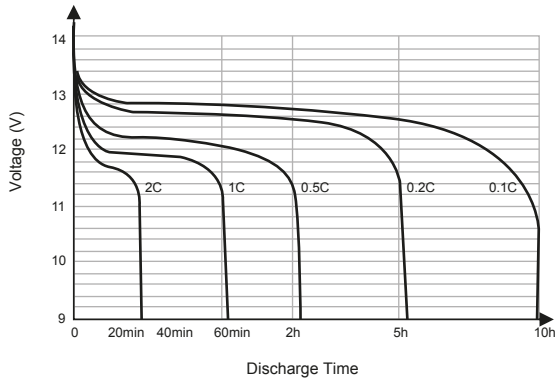

Different Temperature Discharge Curve (0.5C)

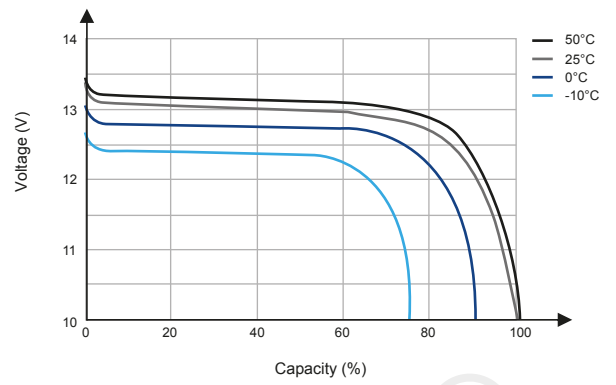

State of Charge Curve (0.5C, 25°C)

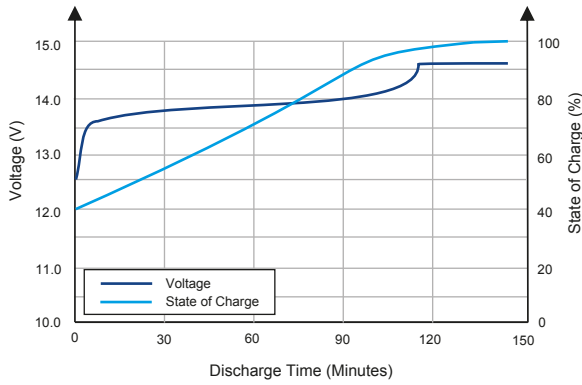

Charging Characteristics (0.5C, 25°C)

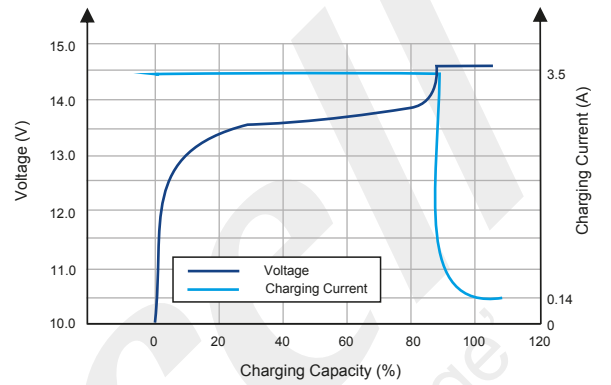

Cycle Life on D.O.D (25°C)

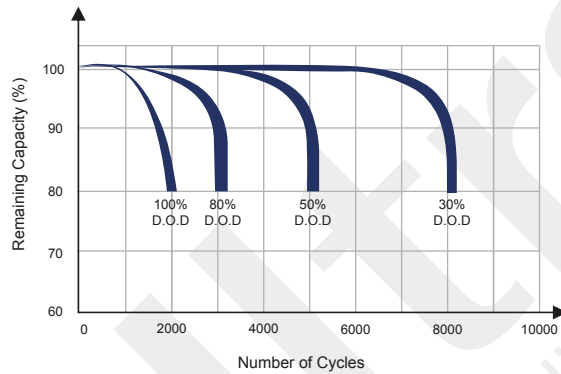

Temperature on Self Discharge Curve

